

# The grand challenge of quantum computing: bridging the capacity gap

Alexandre Zagoskin  
Department of Physics  
Loughborough University

# My background



D::wave

Loughborough  
University

<http://journal.frontiersin.org/journal/ict/section/quantum-computing>

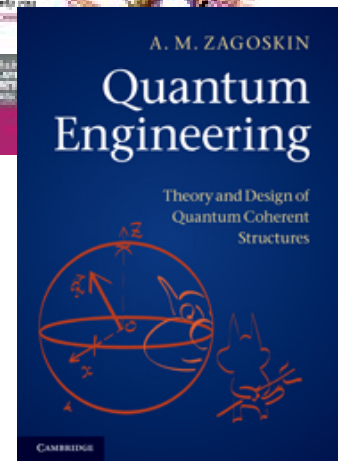
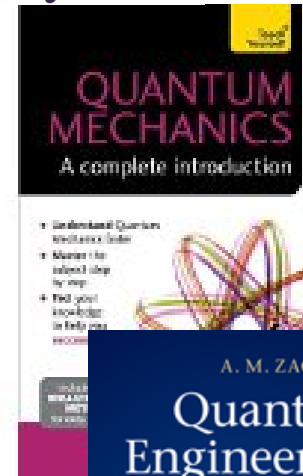
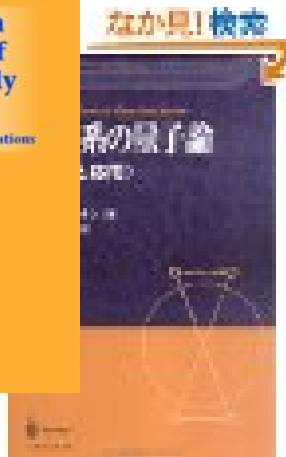
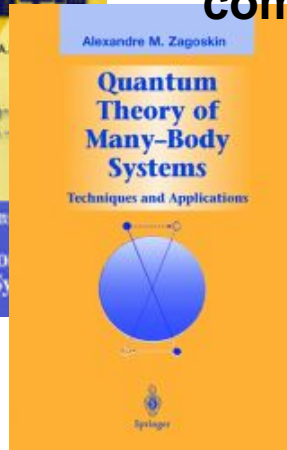
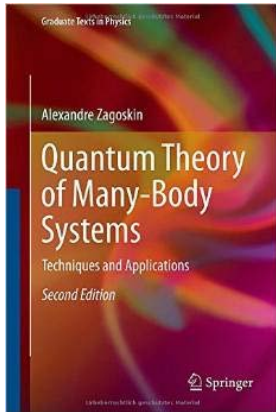

- The fabrication and control of macroscopic artificial quantum structures, such as qubits, qubit arrays, quantum annealers and, recently, quantum metamaterials, have witnessed significant progress over the last 15 years. This was a surprisingly quick evolution from theoretical musings to what can now be called quantum engineering [the observation of such phenomena even in a single superconducting device was considered a truly challenging task as late as in 1980]. Today, we stand at the point where existing theoretical and computational tools become inadequate for predicting, analysing, and simulating the behaviour of such structures, in which quantum superposition and entanglement are essential.

# Quantum revolution 2.0

- Use of essentially quantum properties of macroscopic quantum coherent devices
  - But:
  - ONE CANNOT EFFICIENTLY MODEL QUANTUM SYSTEMS BY CLASSICAL MEANS!
  - Ergo:
  - BUILD QUANTUM COMPUTERS!
  - But...

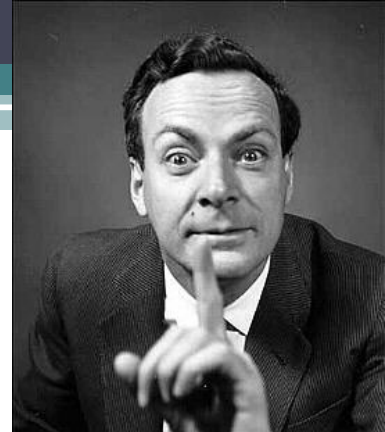

# Richard Feynman (1918 - 1988)

- **Path integral formulation: relates quantum to classical mechanics via variational principle**
  - Heron – Fermat – Lagrange – Hamilton – Dirac

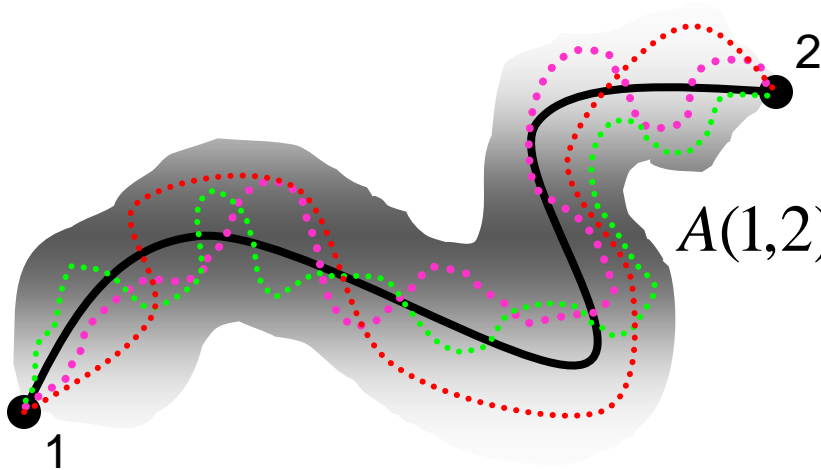

$$A(1,2) = \int Dx(t) \exp\left[-i \frac{S[x(t), \dot{x}(t)]}{\hbar}\right]$$

# Richard Feynman (1918 - 1988)

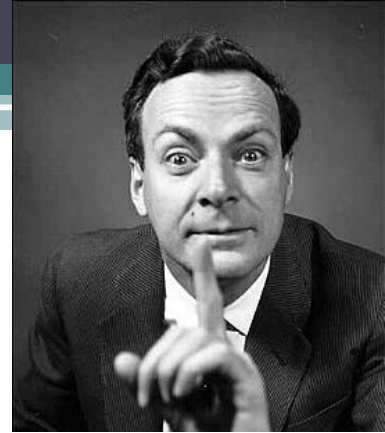

- **Path integral formulation: relates quantum to classical mechanics via variational principle**
  - Heron – Fermat – Lagrange – Hamilton – Dirac

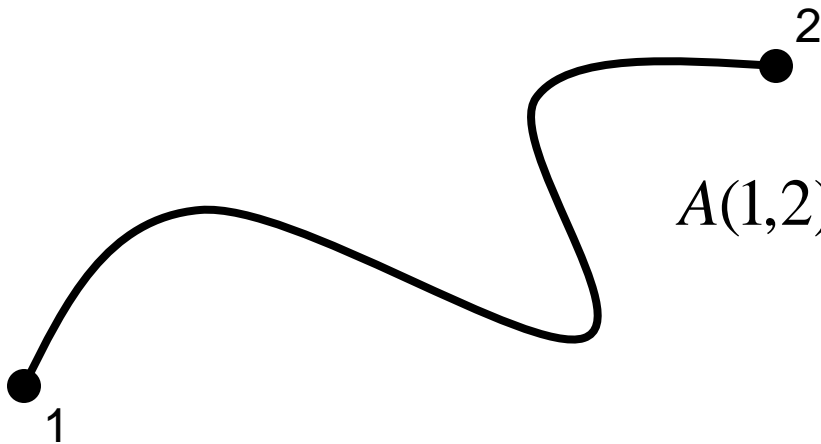

$$A(1,2) = \int Dx(t) \exp \left[ -i \frac{S[x(t), \dot{x}(t)]}{\hbar} \right]$$

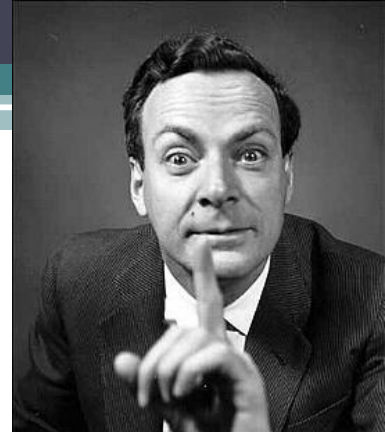

# Richard Feynman (1918 - 1988)

- **Path integral formulation: relates quantum to classical mechanics via variational principle**
  - Heron – Fermat – Lagrange – Hamilton – Dirac

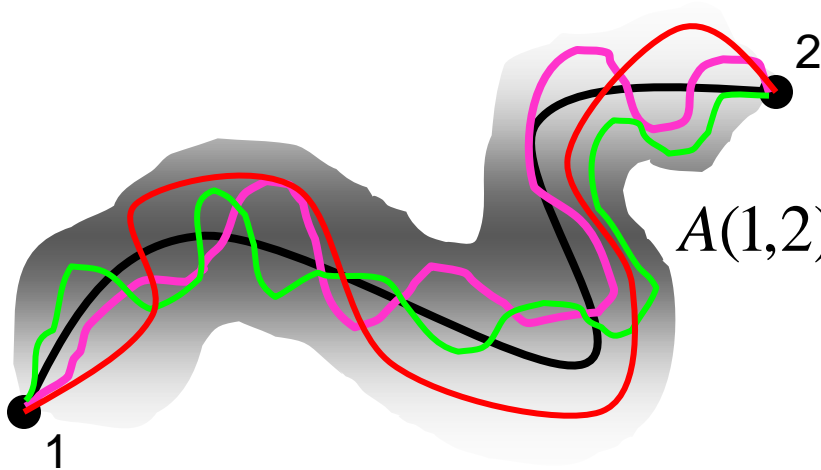

$$A(1,2) = \int Dx(t) \exp \left[ -i \frac{S[x(t), \dot{x}(t)]}{\hbar} \right]$$

# Philosophy of quantum mechanics

- Copenhagen interpretation
- Many worlds
- Environmental decoherence
  - Quantum Darwinism
- Consistent histories
- Pilot wave
- ?
- “Shut up and calculate!”



Philosophy:  
baggage train of science

- **...which is indispensable, but should never ever be in the lead**

# Philosophy:



# Copenhagen vs. Schengen quantum-classical boundary

CLASSICAL



# “Standard” quantum computing

- Precise single and two-qubit quantum manipulations
- Qubit lifetime much shorter than the computational run
- Ergo:
  - Quantum error correction
  - Ancilla qubits, additional operations
  - More noise, shorter lifetime
  - Topological protection etc promising, but...



# Hard to build a Pentium(TM) with steam age technology



# Quantum Slide Rules: Adiabatic quantum computing

$$H(\lambda) = H_i(1 - \lambda) + H_f \lambda$$

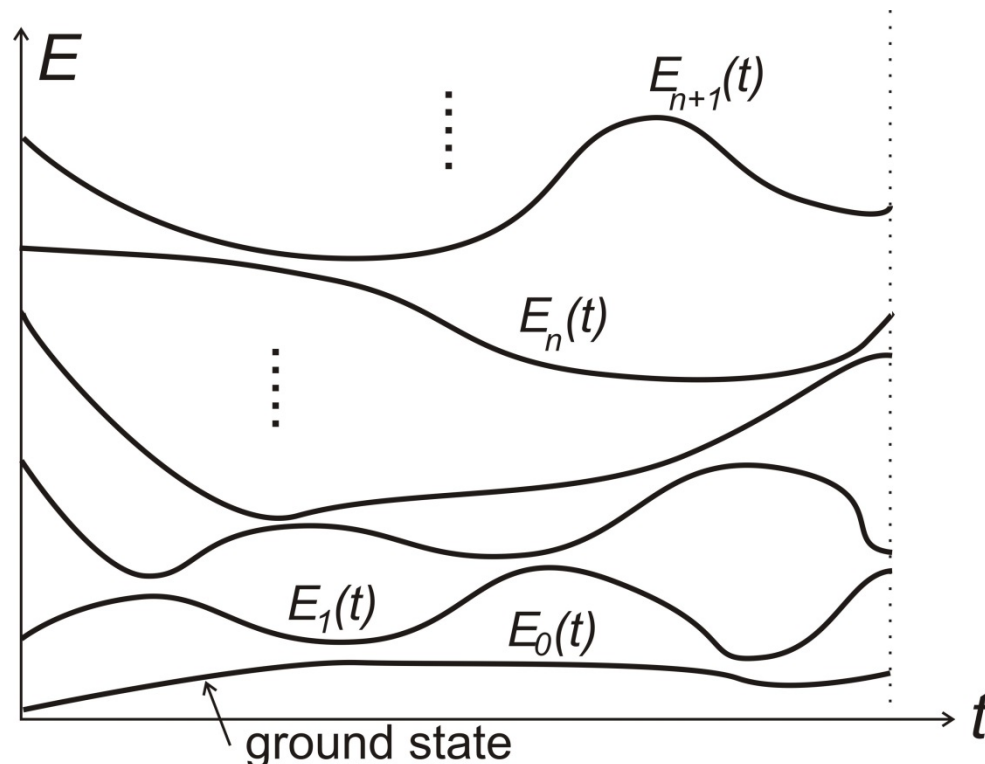

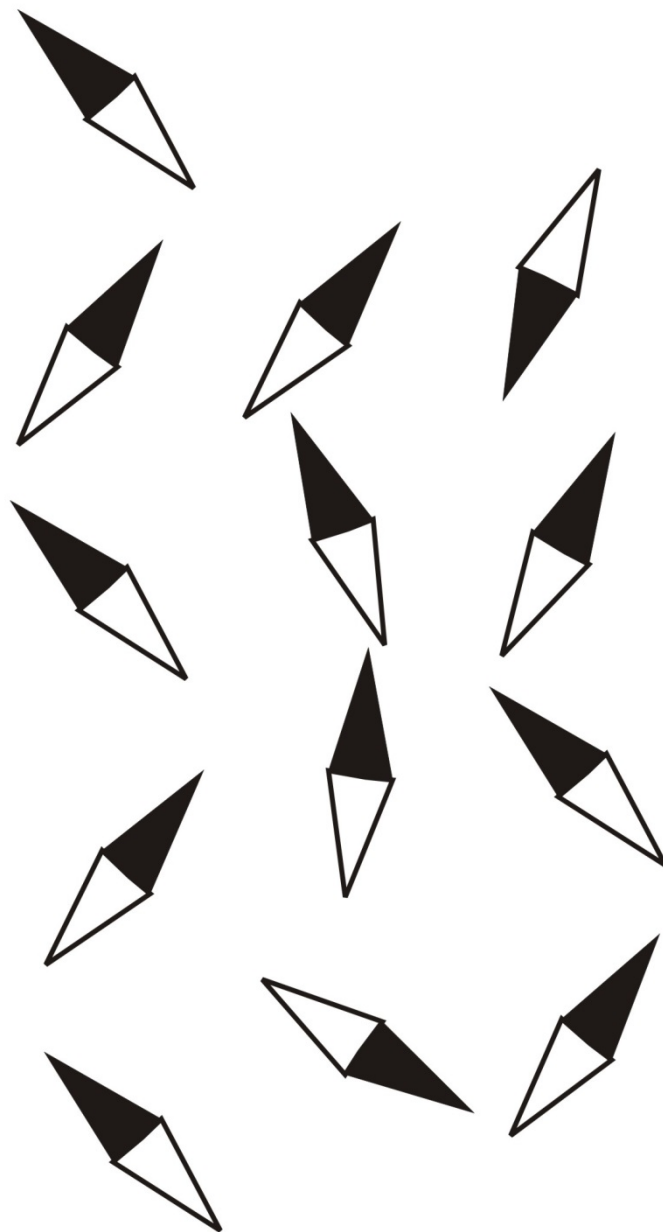
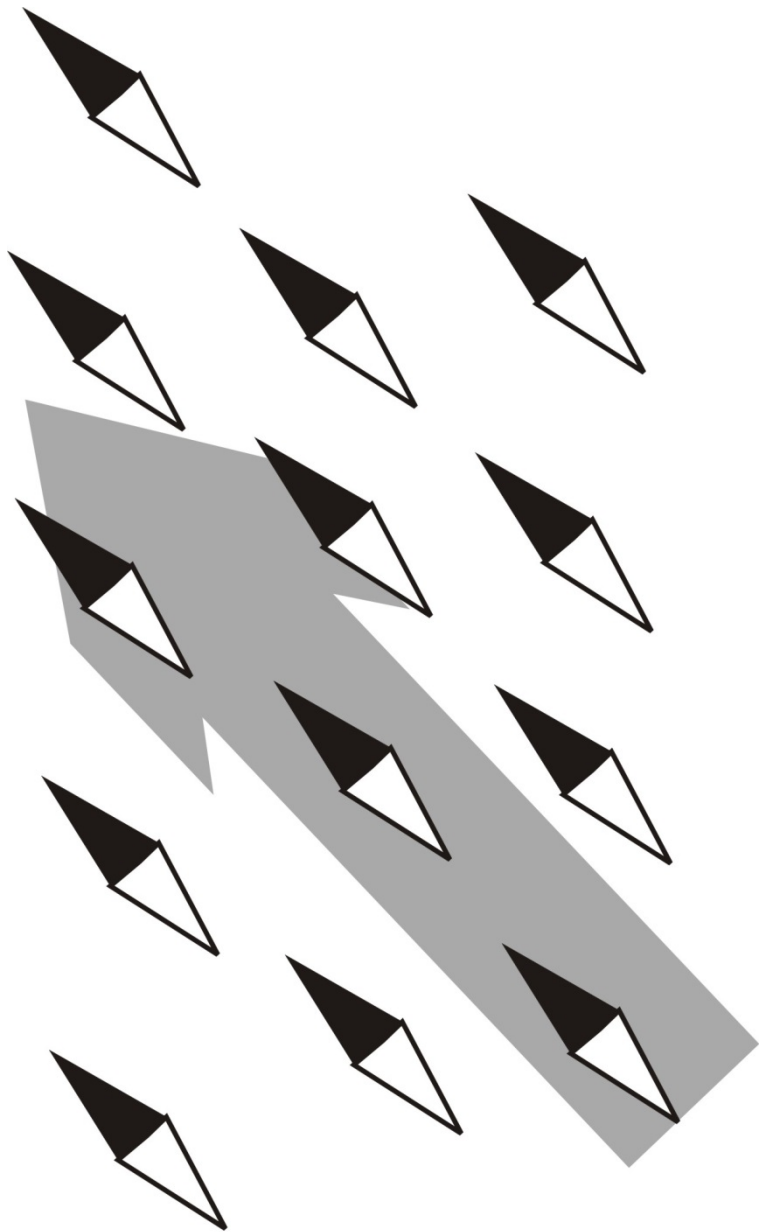

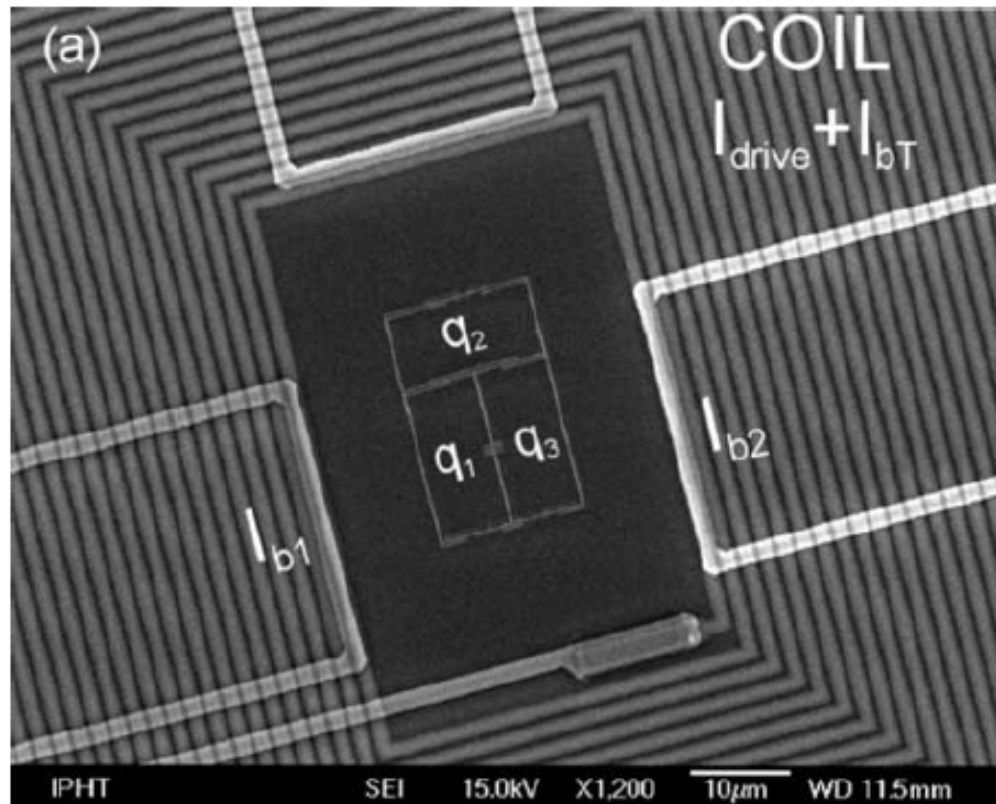

Fig. 6.7. An experimental circuit for the realization of a ( $N = 3$ ) maxcut adiabatic quantum algorithm (from van der Ploeg et al., 2006, © 2007 IEEE, with permission). Aluminium persistent current qubits are placed inside a niobium pickup coil; the tuning fluxes,  $f_{qj}$ ,  $j = 1, 2, 3$  (in units of  $\Phi_0$ ), are induced by the currents in  $\Pi$ -shaped bias lines. The qubits are antiferromagnetically coupled through shared Josephson junctions and (to a lesser degree) mutual inductances. The quantum state of the qubits was determined using the impedance measurement technique (IMT). The circuit parameters,  $J_{12} = J_{23} = J_{13} = 610$  mK,  $\Delta_1 = \Delta_2 = \Delta_3 = 70$  mK, as well as its effective temperature, were determined from fitting the IMT data



# Approximate AQC - a possible application?

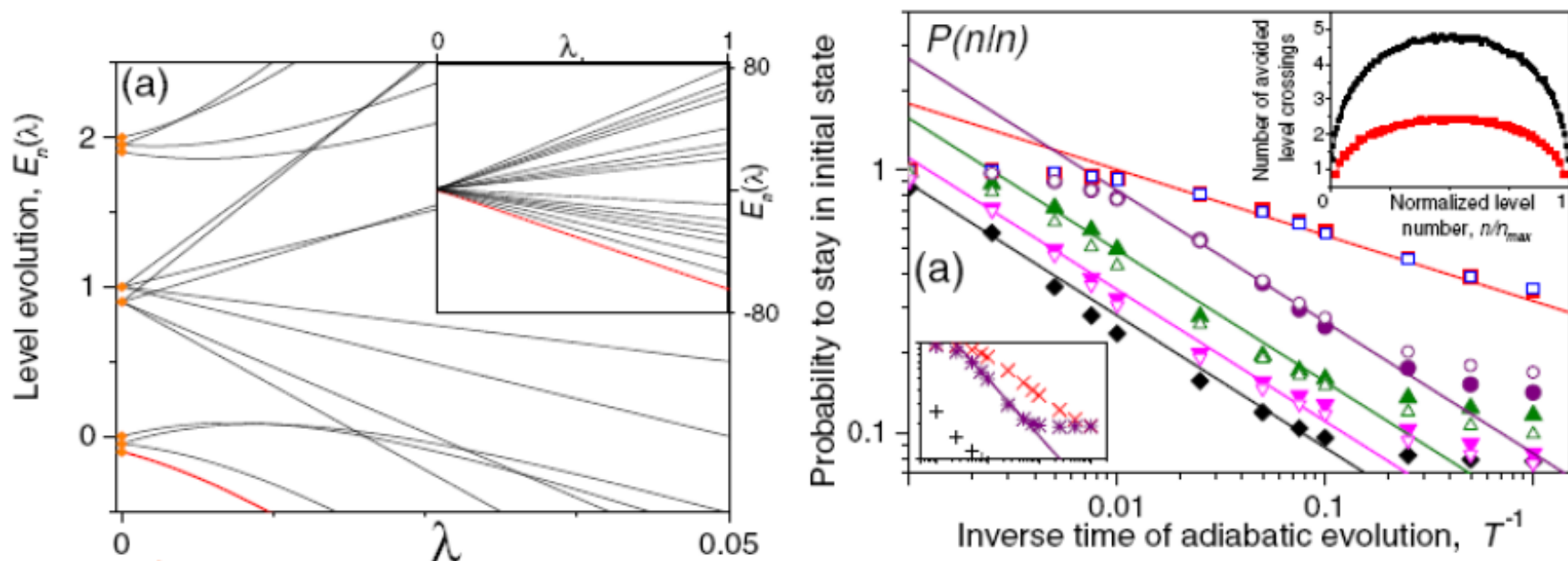

Fig.2.3. Modeling adiabatic quantum evolution in a qubit register.

(Left) Simulation of the CNOT gate for the operation  $|00\rangle \rightarrow |00\rangle$  (involving 4 qubits). (Right) Average probability  $P(n|n)$  for the system to remain in the initial state  $|n\rangle$ , as a function of  $1/T$  (evolution speed), during the adiabatic evolution, for the number of energy levels  $N=50$ . Different symbols correspond to different initial states. Left inset: Same for  $N=150$  levels. Right inset: Average number of avoided level crossings during the evolution for  $N=50$  (red) and  $N=150$  (black) states in the system. From [A.M. Zagoskin et al., Phys. Rev. Lett. 98, 120503 (2007)].

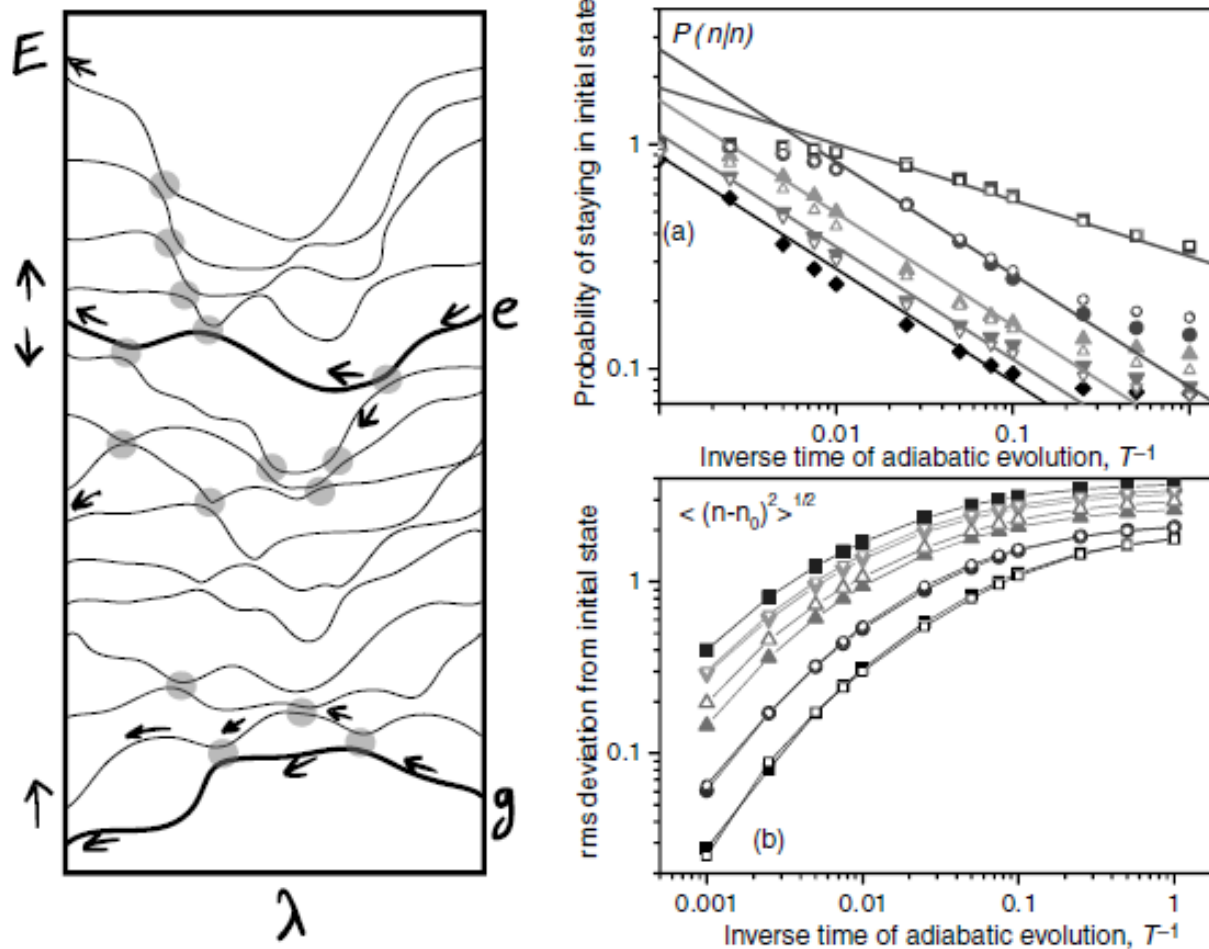

Fig. 6.10. Approximate adiabatic quantum computing (AAQC). (Left) During quasiadiabatic evolution the system can deviate from the initial ground ( $g$ ) or excited ( $e$ ) state via a series of Landau–Zener transitions (grey circles), in a process similar to a random walk. (Right) Probability of staying in the same state (a) and the r.m.s. deviation from the initial state (b) as a function of the inverse evolution time for Hamiltonians from the GUE of random matrix theory (reprinted with permission Zagoskin et al., 2007, © 2007 American Physical Society; cf. Eq. (6.63)). Different symbols correspond to different initial energy eigenstates.

How far do we get from the initial state?

- “LZ diffusion”

$$\langle (n - n_0)^2 \rangle_{\lambda=1} = pk|_{\lambda=1} = pN$$

- $N$  – number of anticrossings per energy level

$$\Delta n = \sqrt{\langle n^2 \rangle} \propto e^{-\alpha T_A}$$

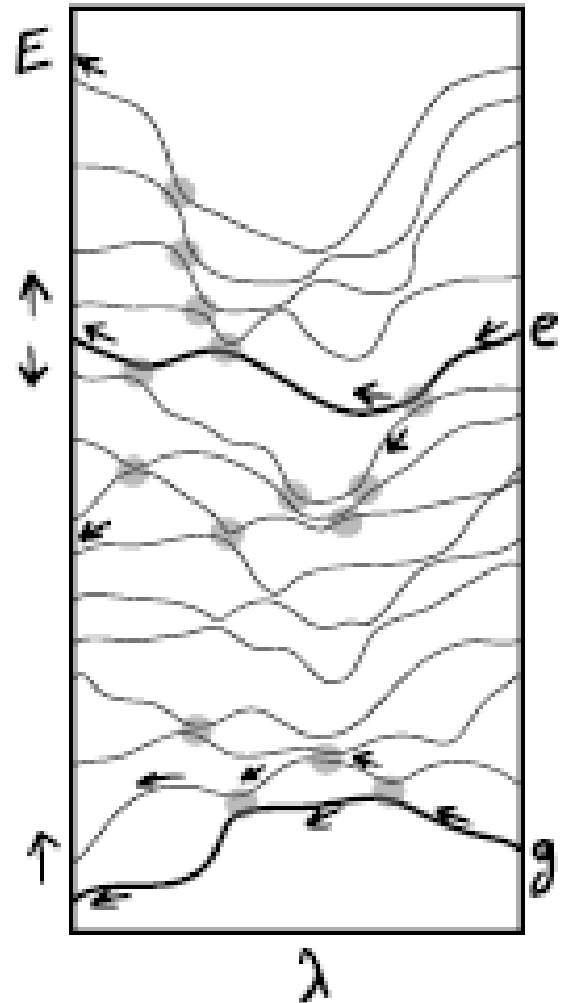

# Qubits for quantum computing and much, much more

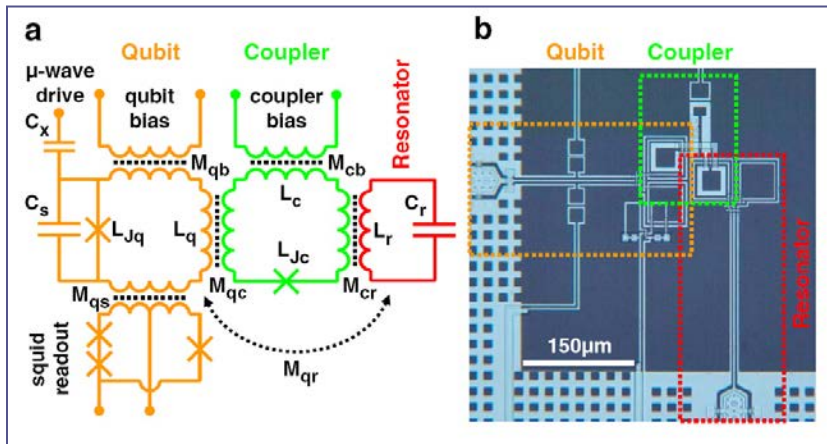

Phase qubit: Allman et al., 2010

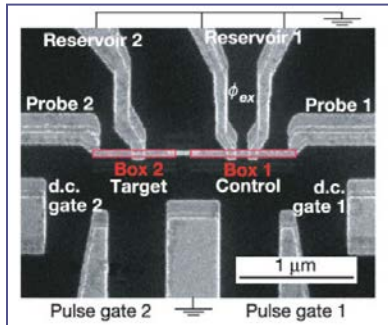

Charge qubits: Yamamoto et al., 2003

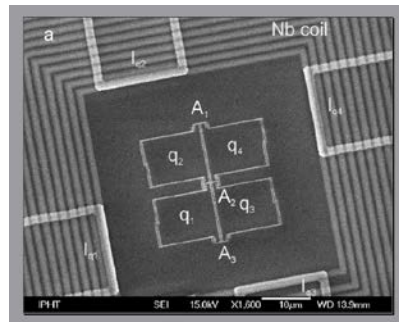

Flux qubits: Grajcar et al., 2006

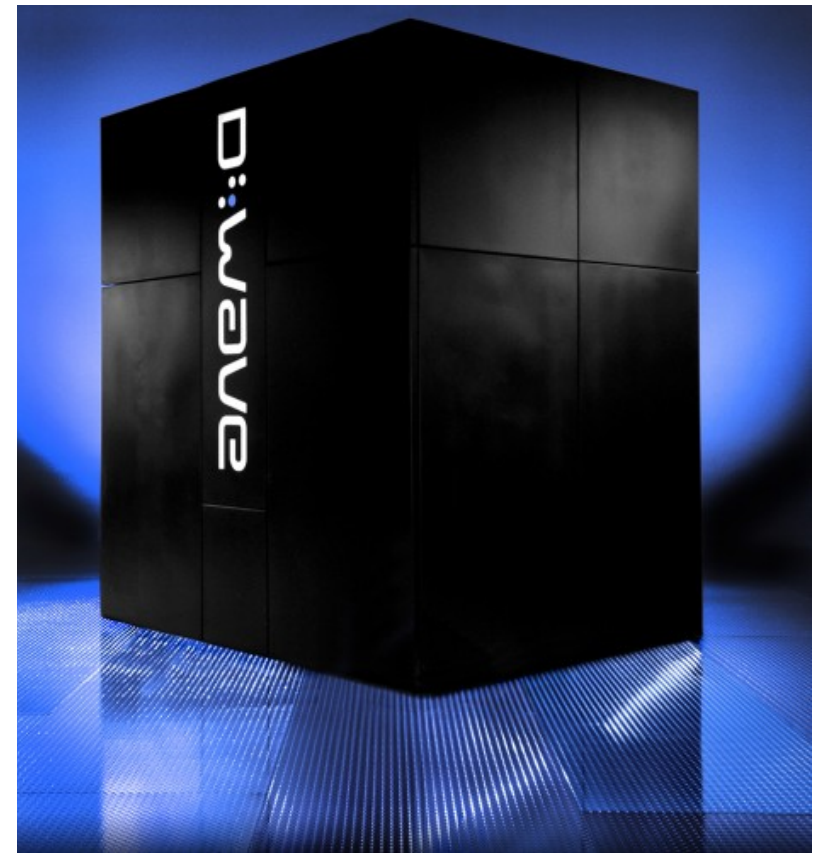



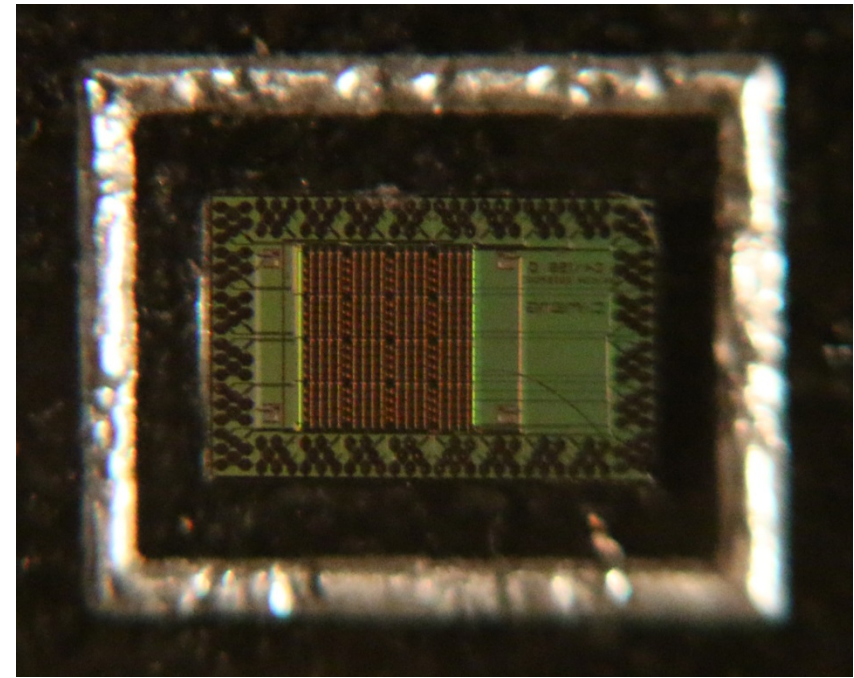

**D:wave**  
The Quantum Computing Company™

Thank You to Our Investors, Board and Staff  
For Being Part of the First D-Wave System Sale



*This Rainier 128 Qubit Quantum processor is from the same wafer lot fabricated and used in the very first D-Wave One system delivered for customer use in December, 2010.*

*This chip is certified to have been cooled to 20 degrees milli-Kelvin.*

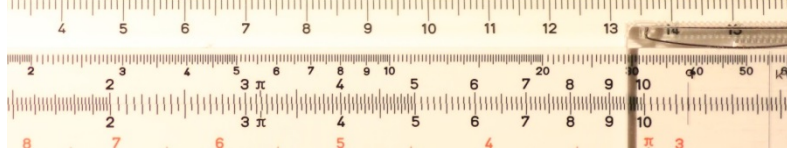

# Why now?

- Fabrication of multiqubit arrays with controlled macroscopic quantum coherence now possible
- Current theoretical methods at their limit and new approaches are urgently needed
- Applications (part of “quantum technologies 2.0”):
  - Integrated quantum limited detection and image processing
  - Quantum optimization
  - Quantum simulation
  - Quantum communication

# D-Wave controversy



- World's biggest collection of qubits
  - Current version of D-Wave 2X had 1152 qubits, 1097 operational
- Quantum operation confirmed for 8-qubit register
- Operation consistent with both quantum and classical models
- Decoherence time of a qubit much shorter than the adiabatic evolution time
- How to tell whether it is quantum, and if so, is it quantum enough?
- 3000× SNAFU
- Recent data (C. Williams at Oxford):  $N$ -qubit system with  $E$  couplers stays within  $\sqrt{N + E}$  from the ground state – consistent with the LZ diffusion picture
- Latest: King et al., “TTT-benchmarking” – faster than conventional algorithms on classical computers

Latest generation Chimaera  $C_{12}$

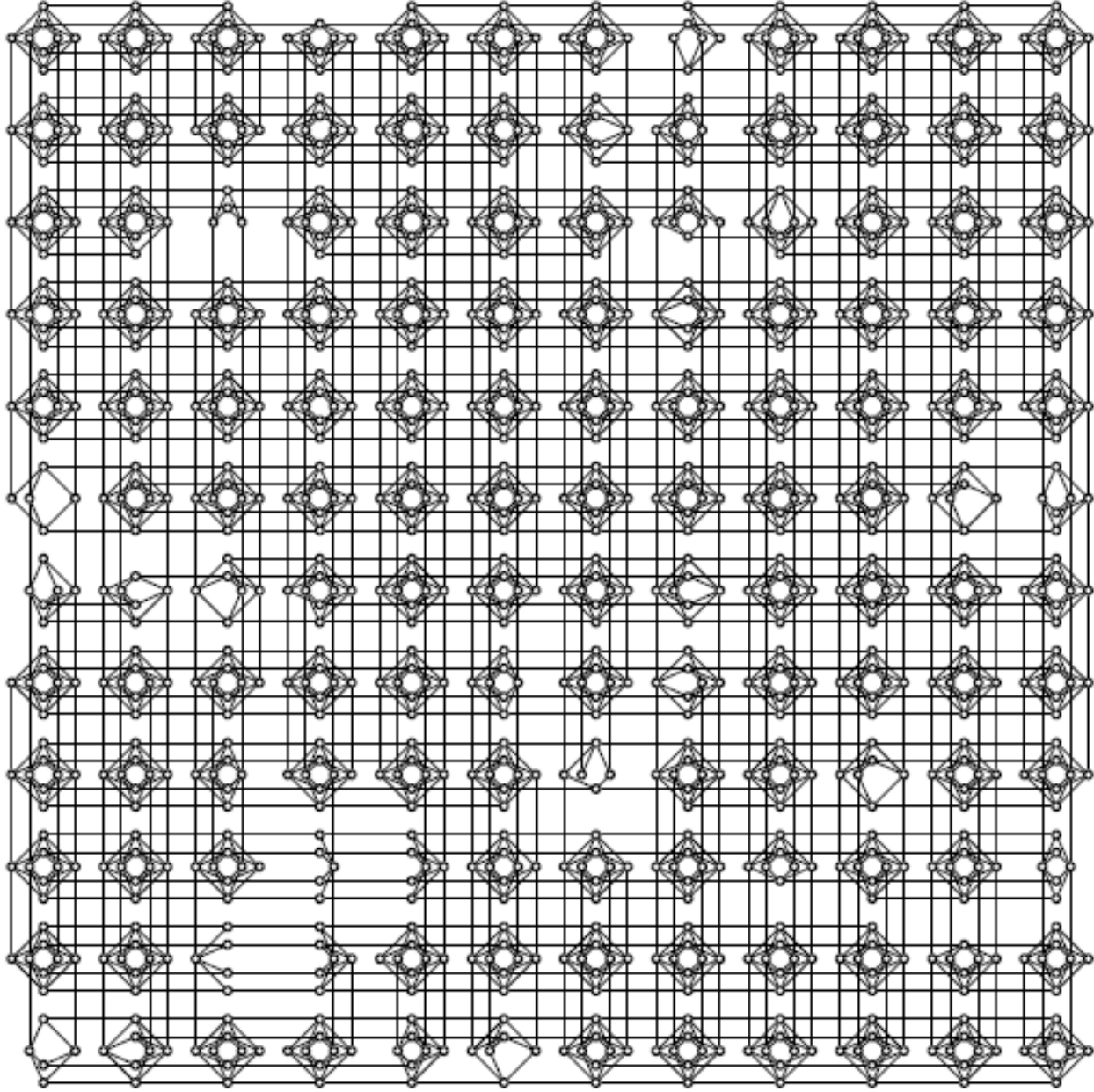



“Time-To-Target” - essentially the same approach as AAQC

- How fast another algorithm can produce the same degree of accuracy (King et al. arxiv 1508.05087)
- BUT:
  - DOES IT REALLY MATTER?
  - “Speed-up” is – scientifically – a minor and ill-defined question compared to the one of “degree of quantumness”

Boixo, S. *et al.* Evidence for quantum annealing with more than one hundred qubits. *Nature Physics* **10**, 218–224 (2014).

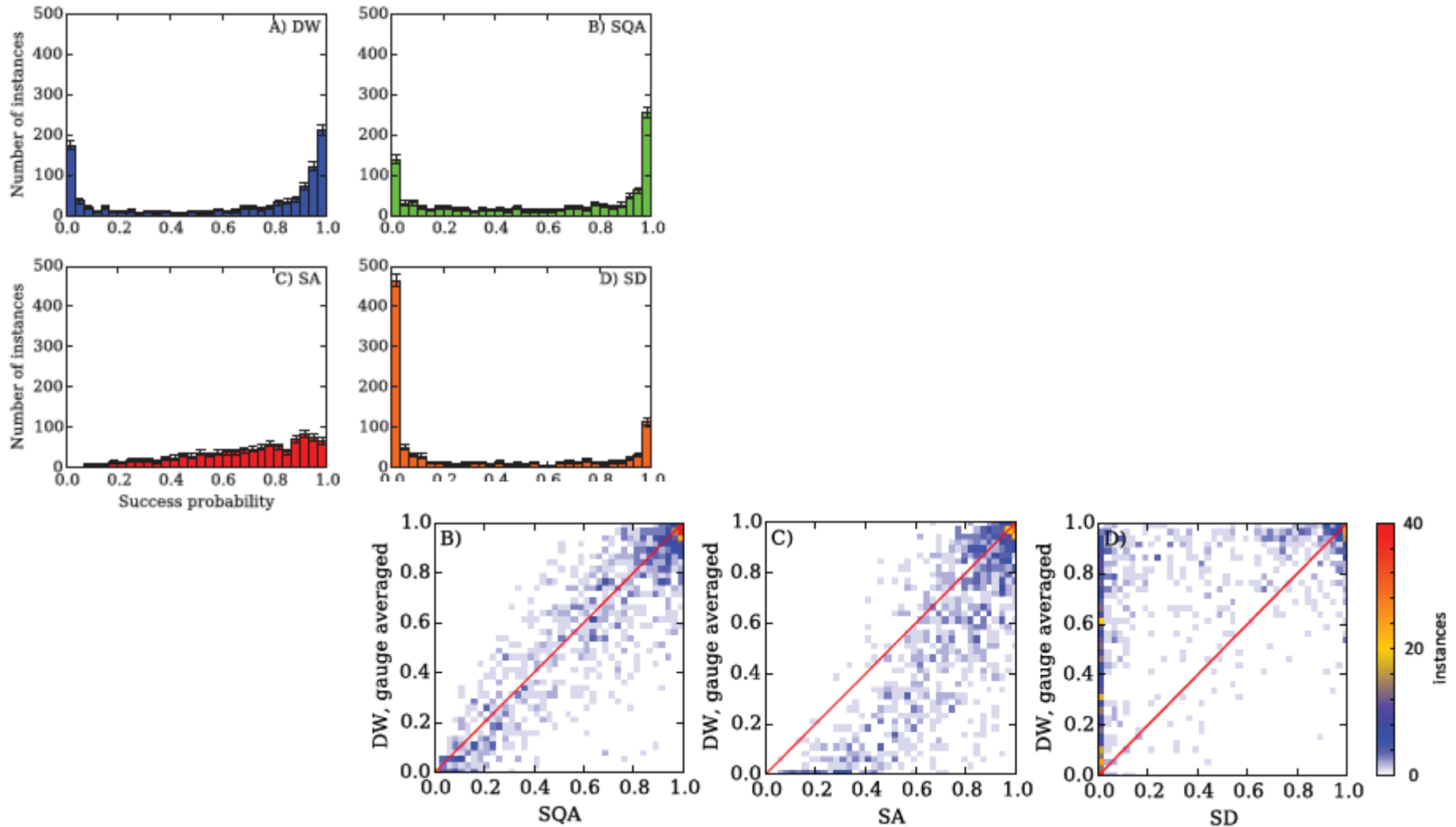



# Classical signature of quantum annealing

John A. Smolin\* and Graeme Smith

IBM Research, Yorktown Heights, NY, USA

**Edited by:**

Jacob Biamonte, Institute for Scientific Interchange Foundation, Italy

**Reviewed by:**

Alexandre M. Zagoskin, Loughborough University, UK  
Scott Aaronson, Massachusetts Institute of Technology, USA

**\*Correspondence:**

John A. Smolin, IBM Research, 1101 Kitchawan Road, Yorktown, NY 10598, USA  
e-mail: smolin@alum.mit.edu

A pair of recent articles [1, 2] concluded that the D-Wave One machine actually operates in the quantum regime, rather than performing some classical evolution. Here we give a classical model that leads to the same behaviors used in those works to infer quantum effects. Thus, the evidence presented does not demonstrate the presence of quantum effects.

**Keywords:** quantum annealing, decoherence, quantum computing, D-Wave, adiabatic quantum computing

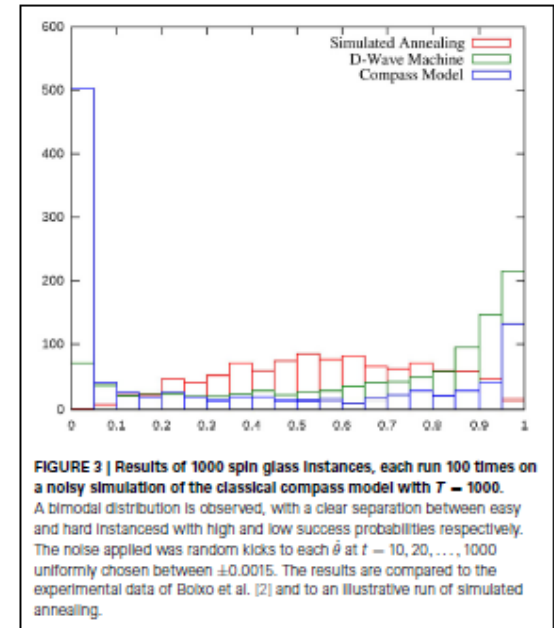

Wang L, Roennow T, Boixo S, Isakov S, Wang Z, Wecker D, et al. Comment on: “Classical signature of quantum annealing.” arXiv:1305.5837 (2013).

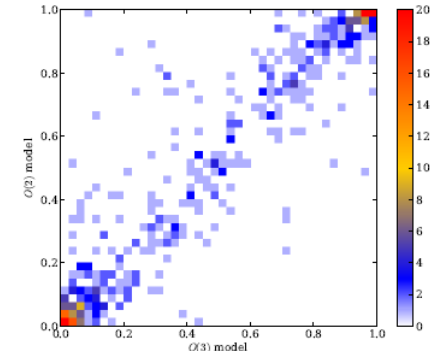
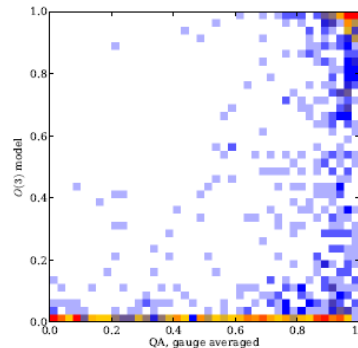
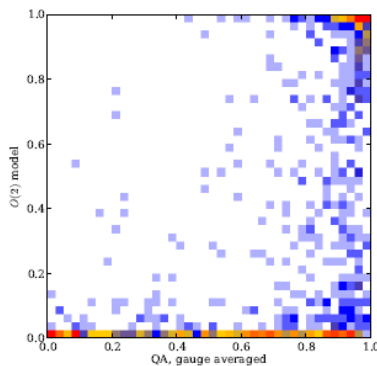

Shin S, Smith G, Smolin J, Vazirani U. How “Quantum” is the D-Wave machine?  
arXiv:1401.7087 (2014).

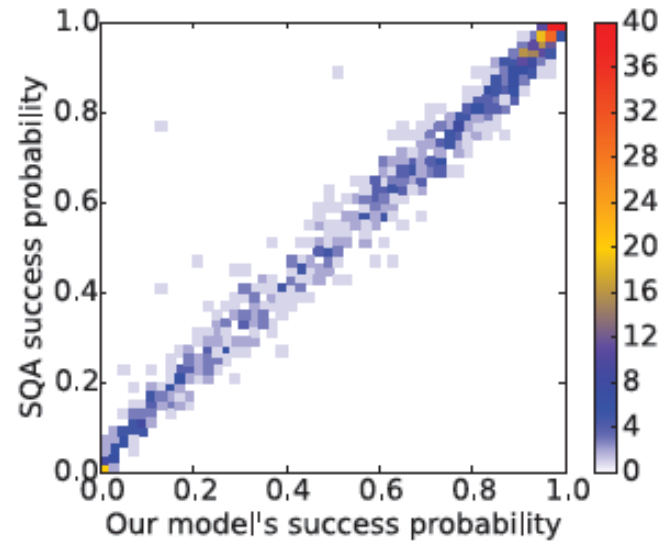
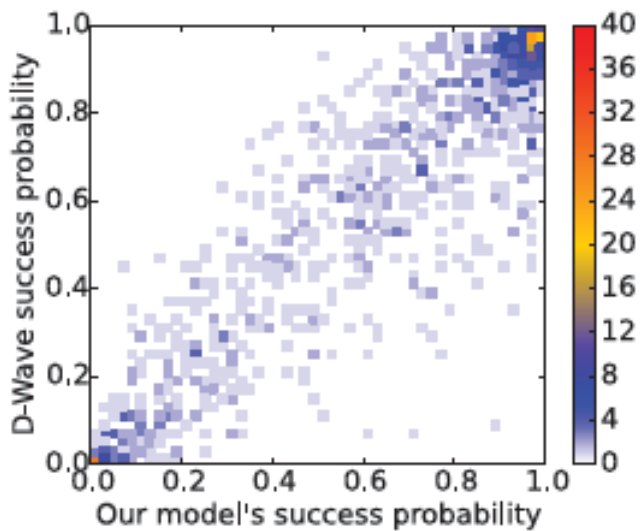
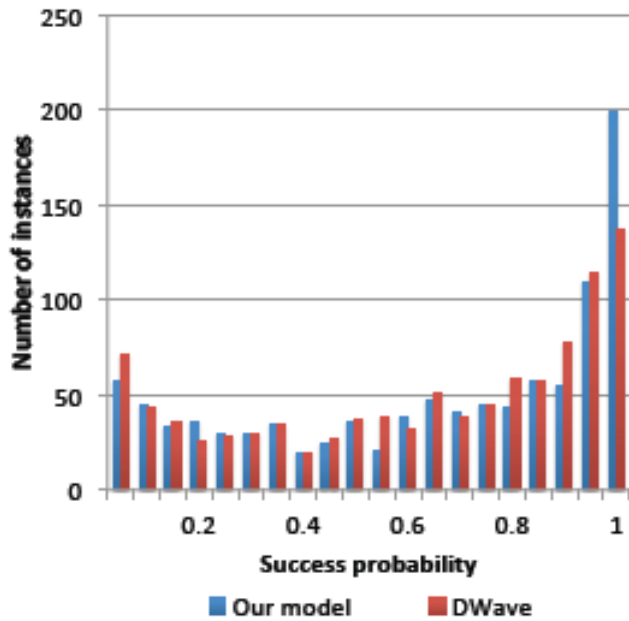

# Grand Challenge

frontiers in  
**PHYSICS**

**PERSPECTIVE ARTICLE**

published: 30 May 2014  
doi: 10.3389/fphy.2014.00033



## How to test the “quantumness” of a quantum computer?

*Alexandre M. Zagoskin<sup>1,2\*</sup>, Evgeni Il'ichev<sup>3</sup>, Miroslav Grajcar<sup>4</sup>, Joseph J. Betouras<sup>1</sup> and Franco Nori<sup>2,5</sup>*

<sup>1</sup> Department of Physics, Loughborough University, Loughborough, UK

<sup>2</sup> Center for Emergent Matter Science, RIKEN, Saitama, Japan

<sup>3</sup> Quantum Detection, Leibniz Institute of Photonic Technology, Jena, Germany

<sup>4</sup> Department of Experimental Physics, Comenius University, Bratislava, Slovakia

<sup>5</sup> Department of Physics, University of Michigan, Ann Arbor, MI, USA

### **Edited by:**

Jacob Biamonte, ISI Foundation,  
Italy

### **Reviewed by:**

Vasileios Basios, Université Libre de  
Bruxelles, Belgium

James Daniel Whitfield, Vienna  
Center for Quantum Science and  
Technology, Austria

José Geraldo Peixoto De Faria,  
Centro Federal de Educação  
Tecnológica de Minas Gerais, Brazil

### **\*Correspondence:**

Alexandre M. Zagoskin, Department  
of Physics, Loughborough  
University, Loughborough LE11 3TU,  
UK  
e-mail: a.zagoskin@lboro.ac.uk

Recent devices, using hundreds of superconducting quantum bits, claim to perform quantum computing. However, it is not an easy task to determine and quantify the degree of quantum coherence and control used by these devices. Namely, it is a difficult task to know with certainty whether or not a given device (e.g., the D-Wave One or D-Wave Two) is a quantum computer. Such a verification of quantum computing would be more accessible if we already had some kind of working quantum computer, to be able to compare the outputs of these various computing devices. Moreover, the verification process itself could strongly depend on whether the tested device is a standard (gate-based) or, e.g., an adiabatic quantum computer. Here we do not propose a technical solution to this quantum-computing “verification problem,” but rather outline the problem in a way which would help both specialists and non-experts to see the scale of this difficult task, and indicate some possible paths toward its solution.

**Keywords:** quantum computing, adiabatic quantum computing, quantum coherence, quantum annealing, D-Wave Systems, quantum simulations, quantum speed-up

# Grand Challenge

frontiers in  
ICT

SPECIALTY GRAND CHALLENGE ARTICLE

published: 27 October 2014  
doi: 10.3389/fict.2014.00002



## The grand challenge of quantum computing: bridging the capacity gap

Alexandre Zagoskin\*

Loughborough University, Loughborough, UK

\*Correspondence: a.zagoskin@lboro.ac.uk

Edited and reviewed by:

Tobias Lindstrom, National Physical Laboratory, UK

**Keywords:** Quantum computing, quantum simulation, quantum engineering, testing limits of applicability of quantum mechanics, quantum metamaterials

The fabrication and control of macroscopic artificial quantum structures, such as qubits (Mooij et al., 1999; Nakamura et al., 1999; Friedman et al., 2000), qubit arrays (Johnson et al., 2011; Barends et al., 2014), quantum annealers (Boixo et al., 2013) and, recently, quantum metamaterials (Macha et al., 2014), have wit-

nesses for large enough systems, we will be unable to discover them because of our inability to tell what exactly quantum mechanics would predict.

Let us take the optimistic view that quantum computing is not fundamentally restricted by, for example, the size of a system capable of demonstrating quantum

mechanics for large enough systems, we will be unable to discover them because of our inability to tell what exactly quantum mechanics would predict.

amenable to the approaches that have proven to work very well in numerous applications in condensed matter physics and quantum statistical mechanics. Therefore, with such earlier breakthroughs in mind, the task at hand will be difficult yet not impossible, and more than worth the effort.

# Quantum *engineering* for QT2.0

- Accommodating incompatible requirements
- Using “rule-of-thumb” estimates for characterizing and predicting the system’s performance and reliability
- Heuristics
- Scaling
- “Engineering is about building reliable structures using non-reliable components”

# Bridging the quantum gap

- Develop *efficient* methods of predicting behaviour of *large quantum* systems using *classical* means – without violating Feynman's dictum
  - Statistical predictions – for *classes* of systems, valid on average
  - Extension of methods of quantum many-body theory and quantum statistics
  - How to do this?



# For example...

- Pechukas-Yukawa (generalized Calogero-Sutherland)

$$\frac{d}{d\lambda}x_m = v_m; \quad \frac{d}{d\lambda}v_m = 2 \sum_{m \neq n} \frac{|l_{mn}|^2}{(x_m - x_n)^3}; \quad \frac{d}{d\lambda}l_{mn} = \sum_{k \neq m, n} l_{mk} l_{kn} \left( \frac{1}{(x_m - x_k)^2} - \frac{1}{(x_k - x_n)^2} \right)$$

where  $x_n(\lambda) = E_n(\lambda)$ ,  $v_n(\lambda) = \langle n | Z H_b | n \rangle$ , and  $l_{mn}(\lambda) = (E_m(\lambda) - E_n(\lambda)) \langle m | Z H_b | n \rangle$ . Equations (2) describe the classical Hamiltonian dynamics of a 1D gas with repulsion, where  $\lambda$  plays the role of time, and the  $n$ th “particle” has a position  $x_n(\lambda)$  and velocity  $v_n(\lambda)$ . The particle-particle repulsion is determined by the “relative angular momenta”  $l_{mn}(\lambda)$ .

- and the corresponding BBGKY chain:

$$\left[ \frac{\partial}{\partial \lambda} + v \frac{\partial}{\partial x} \right] f_1(x, v, n) = 2 \frac{\partial}{\partial v} \sum_m \int dl dy du \frac{|l|^2}{(y-x)^3} f_2(x, v, n; y, u, m; l).$$

$$\left[ \frac{\partial}{\partial \lambda} + v \frac{\partial}{\partial x} - 2\Gamma \left( \sum_m \mathcal{P} \int dy du \frac{f_1(y, u, m)}{(y-x)^3} \right) \frac{\partial}{\partial v} \right] f_1(x, v, n) = I_{\text{St}}$$

# Or: scaling approach

- and the use of scale models based, e.g., on quantum metamaterials



# Quantum metamaterials:

- Artificial optical media that have the following properties:
  - They are composed of quantum coherent unit elements with engineered parameters
  - Quantum states of these elements can be controlled
  - The whole structure can maintain global quantum coherence for longer than the traversal time of a relevant electromagnetic signal

- Quantum metamaterials can be realized using different technologies
- They are generally easier to realize than quantum computers
  - An (adiabatic) quantum computer can be considered a special, complex case of a quantum metamaterial
- They can provide a good testing ground for the investigation of “quantumness” in macroscopic systems

# QMMs from 2008 to 2014

- Theoretical proposal:

- Rakhmanov, Zagoskin, Saveliev & Nori, Phys. Rev. B 77, 144507 (2008)

- Zagoskin, Rakhmanov, Saveliev & Nori, Phys. Stat. Solidi B 246, 955 (2009)

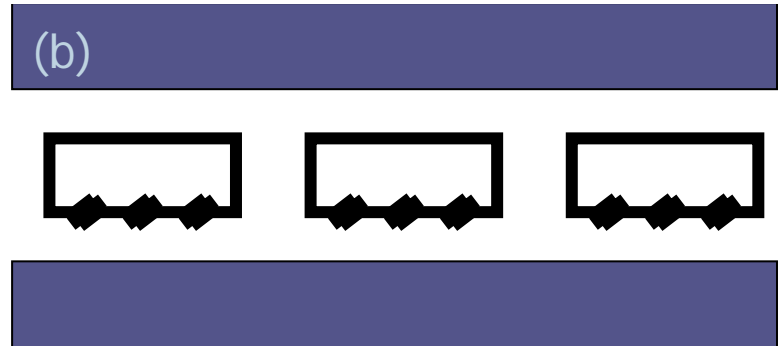
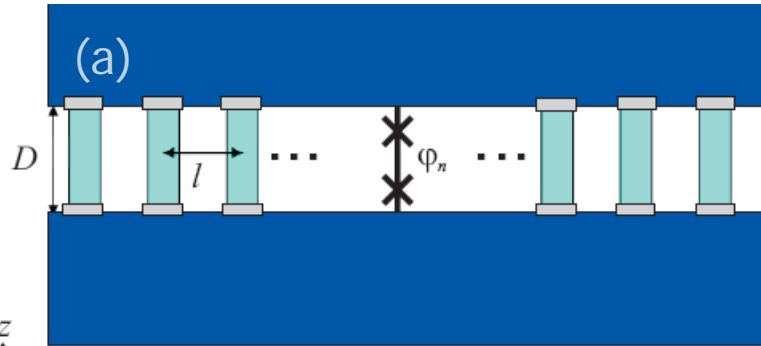

- Proof of principle: Astafiev, Zagoskin et al., Science (2010)

- Experimental prototype: Macha et al. (2013)

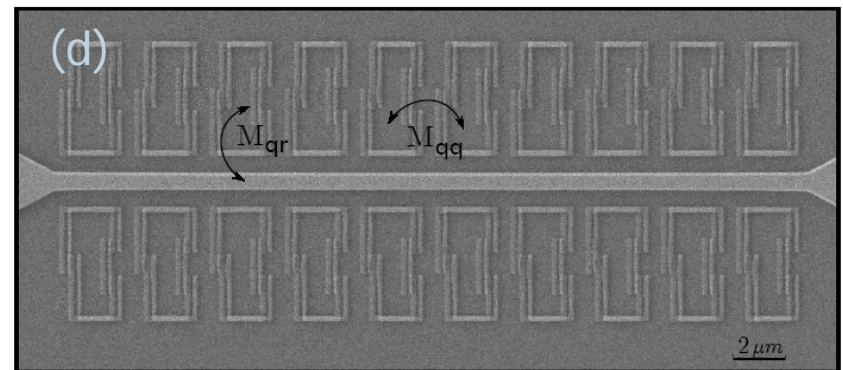
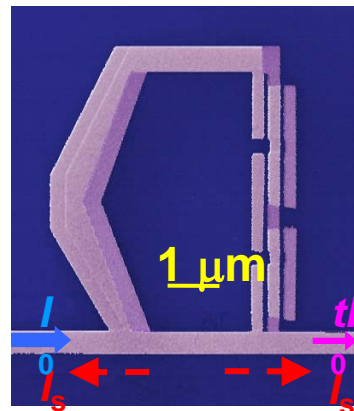
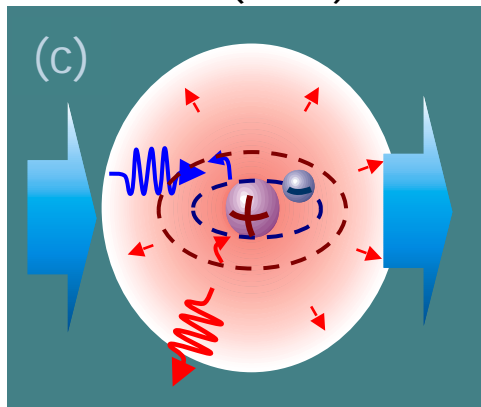

20:55, 30 сентября 2013

## Российские физики создали первый в мире квантовый метаматериал

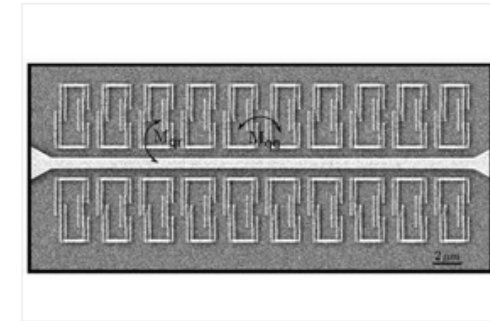

20 С-образных кубитов по обеим сторонам резонатора, электронная микрофотография  
Изображение: Pascal Meche et al., 2013, arXiv:1309.5268

Российско-германская группа физиков под руководством Алексея Уstinova из Российского квантового центра создала первый в мире материал на основе твердотельных сверхпроводящих кубитов. Описание появилось в виде **препринта** в архиве Корнельского университета. В работе также **пишет** блог Technology Review.

PHYSICS > THE FIRST QUANTUM METAMATERIAL RAISES MORE QUESTIONS THAN IT ANSWERS

### first quantum metamaterial raises more questions than it answers

in Anthony on October 4, 2013 at 2:52 pm | 9 Comments

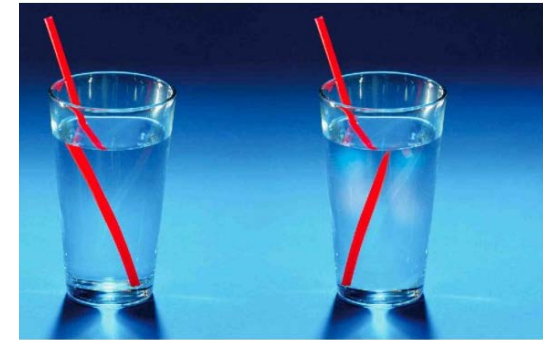

This Article German material scientists have created the world's first quantum metamaterial. This new material

**MIT Technology Review**

NEWS & ANALYSIS FEATURES VIEWS MULTIMEDIA DISCUSSIONS TOPICS POPULAR: EMTECHMIT BIT

VIEW

- Share icon
- Print icon
- Facebook icon
- Twitter icon
- Plus icon
- RSS icon

Emerging Technology From the arXiv  
September 30, 2013

# World's First Quantum Metamaterial Unveiled

German researchers have designed, built, and tested the first metamaterial made out of superconducting quantum resonators.

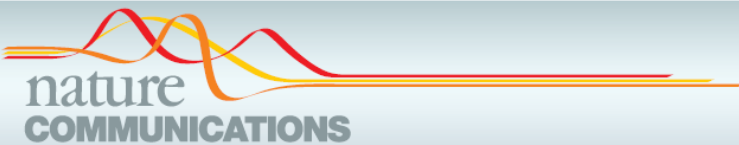

## ARTICLE

Received 1 Jul 2014 | Accepted 5 Sep 2014 | Published 14 Oct 2014

DOI: 10.1038/ncomms6146

# Implementation of a quantum metamaterial using superconducting qubits

Pascal Macha<sup>1,2,3</sup>, Gregor Oelsner<sup>1</sup>, Jan-Michael Reiner<sup>4,5</sup>, Michael Marthaler<sup>4,5</sup>, Stephan André<sup>4,5</sup>, Gerd Schön<sup>4,5</sup>, Uwe Hübner<sup>1</sup>, Hans-Georg Meyer<sup>1</sup>, Evgeni Il'ichev<sup>1,6</sup> & Alexey V. Ustinov<sup>2,6,7</sup>

# Conclusions

- Quantum revolution 2.0 has the potential for both fundamental breakthroughs and developing disruptive new technologies, new IP and business opportunities
- This potential cannot be realized if the “capacity gap” is not bridged - i.e. if a way is not found to efficiently characterize and predict the essential features of large quantum systems including quantum coherences and entanglement
- The methods for achieving this goal can be developed by generalizing methods of quantum many-body physics and quantum statistics
- This goal can be only achieved in a close collaboration between theory and experiment